

SERVICE MANUAL

STEREO AMPLIFIER **SANSUI AU-2200**

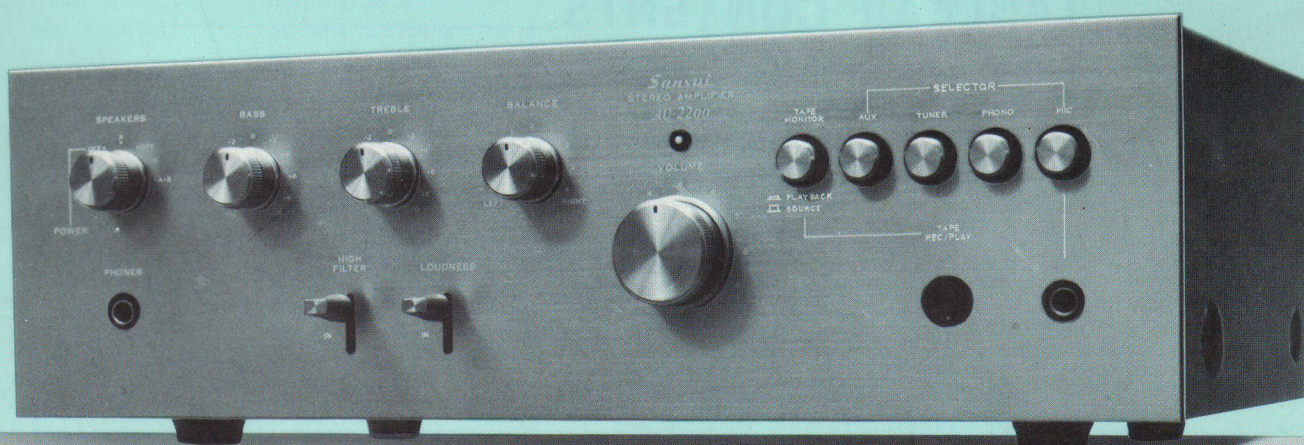

Sansui

SANSUI ELECTRIC CO., LTD.

This service manual is designed for service engineers to repair, adjust, maintain and order the replacement parts of the AU-2200 correctly. When ordering the parts, use the stock number and parts name specifically referring to the Parts Locations & Parts List. For general usage and maintenance of the unit, please refer to the Operating Instructions attached with the unit.

TABLE OF CONTENTS

<u>Section</u>	<u>Title</u>	<u>Page</u>
1.	SPECIFICATIONS	2
2.	BLOCK DIAGRAM AND VALUE OF EACH LEVEL	3
3.	TROUBLESHOOTING CHART	4
	3-1. Troubleshooting on Power supply Section.....	4
	3-2. Troubleshooting on Audio Section	4
4.	PARTS LOCATIONS AND PARTS LISTS	5
	4-1. F-2400 Equalizer, Tone Control Circuit Board.....	5
	4-2. F-2200 Main & Power Supply Circuit Board	6
	4-3. F-2406 Selector Switch Circuit Board	6
	4-4. F-2407 Volume Circuit Board	7
	4-5. F-2408 Accessory Circuit Board	7
	4-6. Other Parts (Front Side)	8
	4-7. Other Parts (Top Side)	9
5.	SCHEMATIC DIAGRAM	10
6.	PACKING LIST	back cover
7.	ACCESSORY PARTS LIST	back cover

1. SPECIFICATIONS

POWER OUTPUT (at rated distortion)
 CONTINUOUS RMS POWER OUTPUT
 10 Watts per channel × 2
 (both channels driven)
 LOAD IMPEDANCE 8Ω
 POWER BANDWISE 40 to 20,000Hz
 TOTAL HARMONIC DISTORTION
 less than 0.8%
 (from AUX input)
 Music power (IHF) 50W (4Ω 1,000Hz)
 40W (8Ω 1,000Hz)
 Continuous RMS power output .. 13+13W (8Ω 1,000Hz)
 INTERMODULATION DISTORTION
 (at rated power output, 70Hz: 7KHz=4 : 1 SMPTE
 method)
 OVERALL (from AUX) .. less than 1.0%
 FREQUENCY RESPONSE (at 1 Watt power output)
 OVERALL (from AUX) .. 30 to 40,000Hz ± 1 dB
 EQUALIZATION (at TAPE REC output)
 RIAA Curve
 (30Hz~15KHz ± 1 dB)
 DAMPING FACTOR 30 (8Ω)
 CHANNEL SEPARATION (1KHz at rated power output)
 PHONO better than 45dB
 TUNER, AUX better than 45dB
 IHF HUM AND NOISE
 PHONO better than 65dB
 MIC better than 65dB
 TUNER, AUX better than 75dB
 TAPE PLAY better than 75dB
 INPUT SENSITIVITY AND IMPEDANCE (1KHz for rated
 power output)
 PHONO 2.5mV 50KΩ
 (Max. input capability: 100mV at 0.5% distortion)
 MIC 2.5mV 10KΩ
 TUNER, AUX 150mV 50KΩ
 TAPE RLY (Pin jack) .. 150mV 50KΩ
 TAPE REC/PLAY (DIN socket)
 150mV 50KΩ
 RECORDING OUTPUT
 TAPE REC (Pin jack) 150mV
 TAPE REC/PLAY (DIN socket) .. 30mV
 SWITCHES AND CONTROLS
 BASS +12dB, -12dB (50Hz)
 TREBLE +12dB, -12dB (20KHz)
 LOUDNESS (volume control: -30dB)
 +10dB (50Hz)
 +8dB (10KHz)
 HIGH FILTER -3dB (7KHz, 6dB/oct)

OTHERS

SEMICONDUCTORS
 DIODES 2
 ZENER DIODES 2
 ICs 6
 LED (Light Emited Diode) 1
 POWER REQUIREMENTS
 VOLTAGE 100, 117, 220, 240V 50/60Hz
 CONSUMPTION 45W (rated), 86W (max.)
 DIMENSIONS 400mm (15 $\frac{3}{4}$ " W
 120mm (4 $\frac{3}{4}$ " H
 240mm (9 $\frac{1}{2}$ " D)
 WEIGHT 5.5Kg (12.1 lbs) net
 6.8Kg (15.0 lbs) packed

* Design and specification subject to change without notice for improvements.

2. BLOCK DIAGRAM AND VALUE OF EACH LEVEL

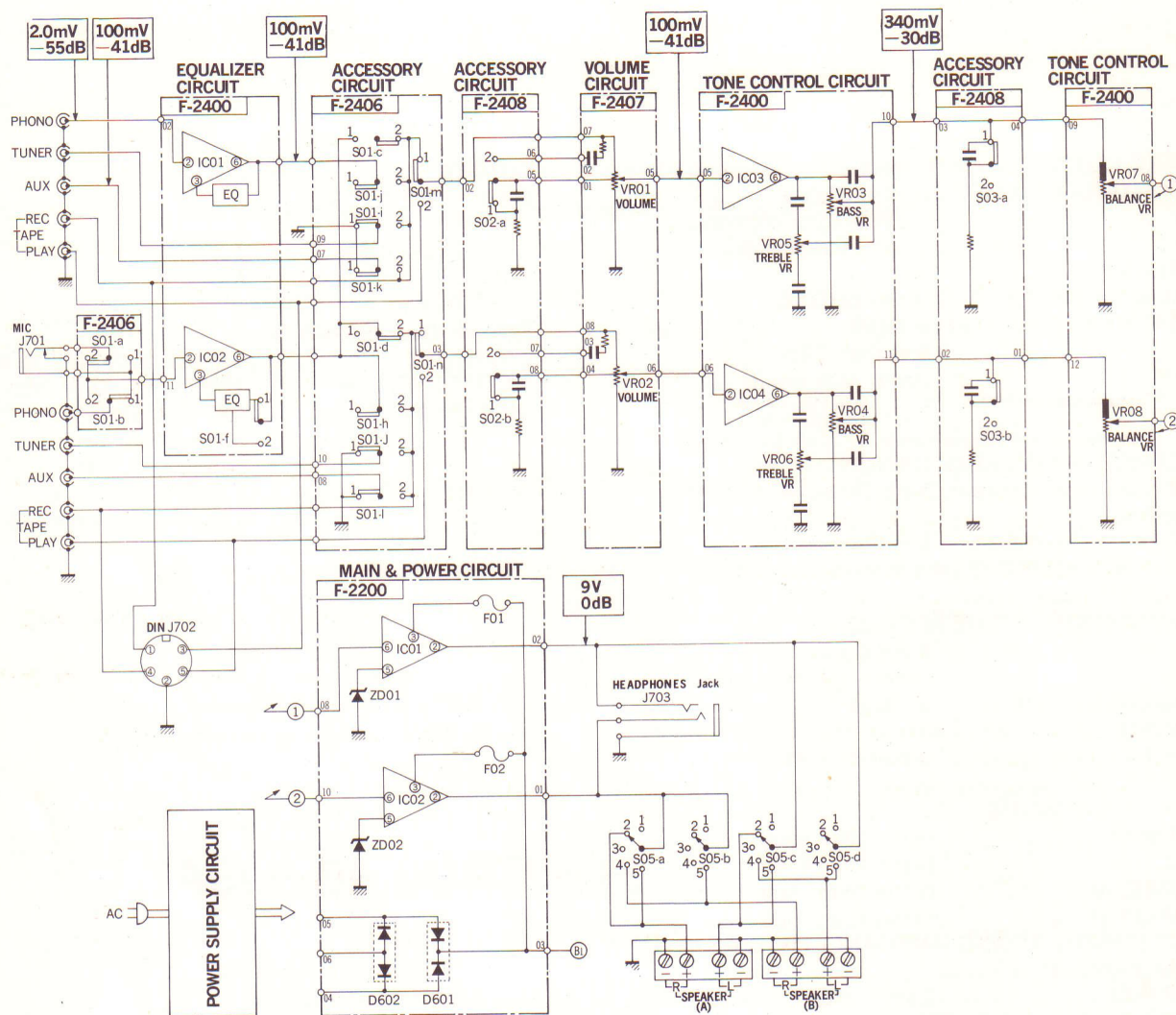

- | | | | | |
|---------------------|--------------------------|----------------------|-------------------------|---------------------------|
| S01 (a~l): SELECTOR | S01 (m, n): TAPE MONITOR | S02 (a, b): LOUDNESS | S03 (a, b): HIGH FILTER | S05 (a~c): POWER SPEAKERS |
| 1. MIC (a~d) | 1. SOURCE | 1. OUT | 1. OUT | 1. POWER OFF |
| 2. PHONO (e~h) | 2. PLAYBACK | 2. IN | 2. IN | 2. A |
| 3. TUNER (i~j) | | | | 3. SPEAKER OFF |
| 4. AUX (k, l) | | | | 4. B |
| | | | | 5. A+B |

Conditions of Level Measuring

※Value of each level in block diagram was measured by the followings.

1. MASTER VOLUME Maximum
2. BASS, TREBLE, BALANCE volume Center
3. Input PHONO 2.0mV 1kHz Sine Wave
AUX 100mV 1kHz Sine Wave
(output impedance of 600Ω at an audio oscillator)

4. Output 9V (10W) 8Ω
Note: Each voltage value is for reference and measured by a VTVM. In some recorders, the actual value is in minor difference from the reference value.

3. TROUBLESHOOTING CHART

<Notices when servicing this unit>

o**On Light Emitted Diode (LED)**

The LED used as Pilot Lamp driven by constant current has characteristics of extreme low reverse break-down voltage (DC 3V) and also it would be easily influenced by discharge voltage from capacitors in power amplifier section.

Therefore, after power switch is turned OFF and lapse of a few seconds, perform the replacement of LED.

o**Notice when replacing IC**

- 1) Do not vent the leads of IC more than 3 times.
- 2) When using a soldering iron, IC should be absolutely isolated from current leakage of the iron. In order to protect IC against break-down, connect a lead wire from the iron to ground (chassis) as shown below. (Fig. 3-1)

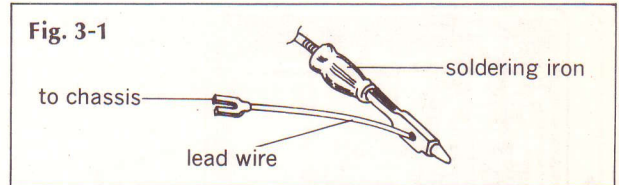

Fig. 3-1
3) As IC is extremely weak against heat; use a soldering iron as shorter as possible.

o**Notice after replacing power IC**

After replacing power IC, check DC bias current (30mA ~ 50mA) on power amplifier section. If the value is under 30mA or over 50mA, the IC must be replaced again because it may be probably caused of troubles again.

Symptom	Check Point	Cause & What to Do
---------	-------------	--------------------

3-1. Troubleshooting on Power Supply Section

1. No power supplied to each section (Power lamp not light)

- | | |
|--|---|
| <p>1-1. AC+30V not supplied to terminal [05] on F-2200</p> | <p>1. Imperfect contact of power supply plug
2. Defective power switch, S05e
3. Imperfect contact of voltage selector, PU701
4. Power fuse F701 open
5. Defective power transformer, T701</p> |
| <p>1-2. AC+30V supplied to terminal [05] on F-2200</p> <p> 1) +45.5V not supplied to terminal [03] on F-2200</p> <p> 2) +45.5V supplied to terminal [03] on F-2200</p> | <p>6. Defective D601, D602 on F-2200
7. Defective LED701</p> |

3-2. Troubleshooting on Audio Section

1. Quick acting fuse open

- | | |
|---|---|
| <p>1-1. After replacement, fuse open again</p> <p> 1) DC bias current is over 50mA</p> | <p>1. Defective IC01 (IC02) on F-2200</p> |
| <p>1-2. After replacement, fuse not open</p> <p> 1) DC bias current is not between 30mA and 50mA</p> | <p>2. Defective IC01 (IC02) on F-2200</p> |

2. AUX inoperative

- | | |
|--|---|
| <p>2-1. +45.5V not supplied to terminal [03] on F-2400</p> | <p>3. Defective power supply section (F-2200)</p> |
| <p>2-2. +45.5V supplied to terminal [03] on F-2400</p> | <p>4. Imperfect contact of SELECTOR switch S01 (K, I)
5. Imperfect contact of TAPE MONITOR switch S01 (m, n)
6. Defective IC03 (IC04) on F-2400</p> |

3. PHONO inoperative

- | | |
|----------------------------------|---|
| <p>3-1. Excessive Distortion</p> | <p>7. Imperfect contact of SELECTOR switch S01 (e~h)
8. Defective IC01 (IC02) on F-2400
9. Imperfect contact of SELECTOR switch S01 (f)</p> |
|----------------------------------|---|

4. MIC inoperative

- | | |
|---------------------------|---|
| <p>4. MIC inoperative</p> | <p>10. Imperfect contact of SELECTOR switch S01 (a~l)
11. Imperfect contact of MIC Jack</p> |
|---------------------------|---|

4. PARTS LOCATIONS AND PARTS LISTS

4-1. F-2400 Equalizer, Tone Control Circuit Board (Stock No. 7560800 Complete Circuit Board F-2400)

Conductor Side

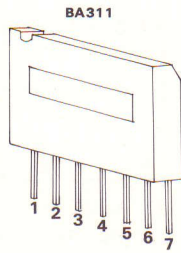
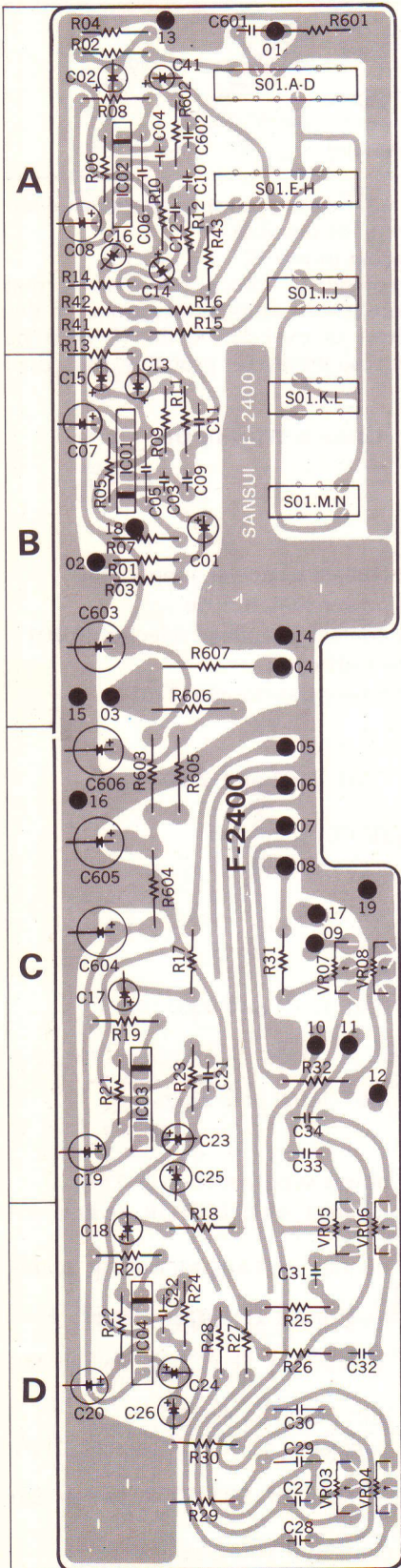

Parts List

Parts No.	Stock No.	Description	Position
IC01, 02	0360171, 2	BA311(E, F)	IC B. A
IC03, 04	0360181, 2	BA311(S)(E, F)	
C01, 02	0515339	3.3 μ F 50V E.C.	A. B
C03, 04	0660470	47pF 50V C.C.	B. A
C05, 06	0660101	100pF	B. A
C07, 08	0511330	33 μ F 10V E.C.	B. A
C09, 10	0600187	0.018 μ F	B. A
C11, 12	0600566	0.0056 μ F	B. A
C13, 14	0513100	10 μ F 25V E.C.	B. A
C15, 16	0519103	0.47 μ F	B. A
C17, 18	0515339	3.3 μ F	C. D
C19, 20	0510101	100 μ F 6.3V E.C.	C. D
C21, 22	0660470	47pF 50V C.C.	C. D
C23, 24	0513100	10 μ F 25V E.C.	C. D
C25, 26	0515109	1 μ F 50V E.C.	C. D
C27, 28	0601277	0.027 μ F	D
C29, 30	0601228	0.22 μ F	D
C31, 32	0601476	0.0047 μ F	D
C33, 34	0601477	0.047 μ F	C
C41	0515109	1 μ F 50V E.C.	A
C601	0601687	0.068 μ F 50V M.C.	A
C602	0660221	220pF 50V C.C.	A
C603	0515221	220 μ F	B
C604	0515101	100 μ F	C
C605	0515221	220 μ F	C
C606	0515101	100 μ F	C
C901	0660100	10pF	50V C.C.
C902	0660100	10pF	
R01, 02	0107222	2.2k Ω	B. A
R03, 04	0107104	100k Ω	B. A
R05, 06	0107104	100k Ω	B. A
R07, 08	0107684	680k Ω	B. A
R09, 10	0107154	150k Ω	B. A
R11, 12	0107123	12k Ω	B. A
R13, 14	0107473	47k Ω	A
R15, 16	0107221	220 Ω	A
R17, 18	0107222	2.2k Ω	C. D
R19, 20	0107684	680k Ω	C. D
R21, 22	0107104	100k Ω	C. D
R23, 24	0107822	8.2k Ω	C. D
R25, 26	0107102	1k Ω	D
R27, 28	0107123	12k Ω	D
R29, 30	0107122	1.2k Ω	D
R31, 32	0107222	22k Ω	C
R41, 42	0107563	56k Ω	A
R43	0107105	1M Ω	A
R601	0107123	12k Ω	A
R602	0107153	15k Ω	A
R603	0103471	470 Ω	C
R604	0103101	100 Ω	C
R605	0103471	470 Ω	C
R606	0103471	470 Ω	B
R607	0162332	3.3k Ω 2W C.R.	B
VR03, 04	1015080, 1	100k Ω (A) \times 2	Variable Resistor
VR05, 06	1015080, 1	100k Ω (A) \times 2	
VR07, 08	1015070, 1	100k Ω (MN) \times 2	
S01(a~n)	1130860	SUB54 Push Switch (5 Stage)	A, B

4-2. F-2200 Main & Power Supply Circuit Board (Stock No. 7570890 Complete Circuit Board F-2200) Conductor Side

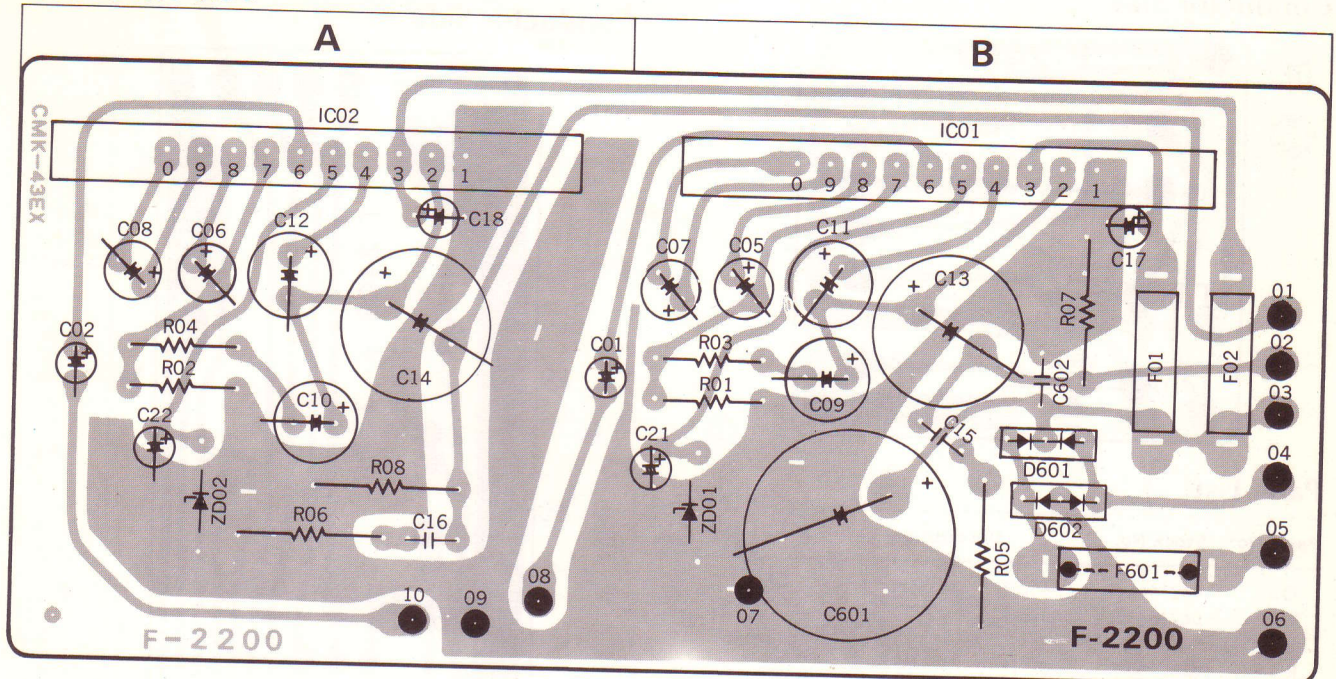

Parts List

Parts No.	Stock No.	Description	Position
IC01, 02	0360130	STK-016B IC	B. A
D601	0310680	10DC-1	Diode B
D602	0310670	10DC-1R	
ZD01, 02	0316290	RD-12E(B) Zener Diode	B. A
C01, 02	0515109	1 μ F 50V E.C.	A. A
C05, 06	0510470	47 μ F 6.3V E.C.	B. A
C07, 08	0512330	33 μ F 16V E.C.	B. A
C09, 10	0515330	33 μ F 50V E.C.	B. A
C11, 12	0513470	47 μ F 25V E.C.	B. A
C13, 14	0514102	1,000 μ F 35V E.C.	B. A
C15, 16	0601477	0.047 μ F 50V M.C.	B. A
C17, 18	0515339	3.3 μ F 50V E.C.	B. A
C21, 22	0515109	1 μ F 50V E.C.	B. A
C601	0549107	1,500 μ F 50V E.C.	B
C602	0652103	0.01 μ F 50V C.C.	
R01, 02	0107470	47 Ω	1/4W C.R. B. A
R03, 04	0107152	1.5k Ω	
R05, 06	0103100	10 Ω	
R07, 08	0103221	220 Ω	
F01, 02	0433610 5937040	2A Quick Acting Fuse Heat Sink	B

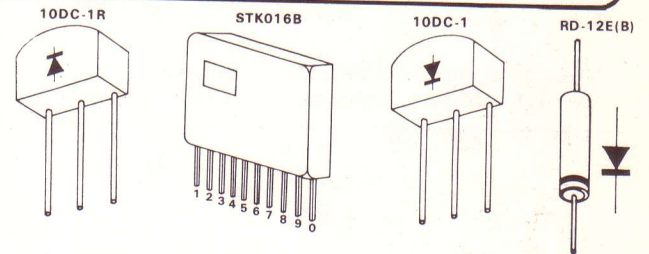

4-3. F-2406 Selector Switch Circuit Board Conductor Side

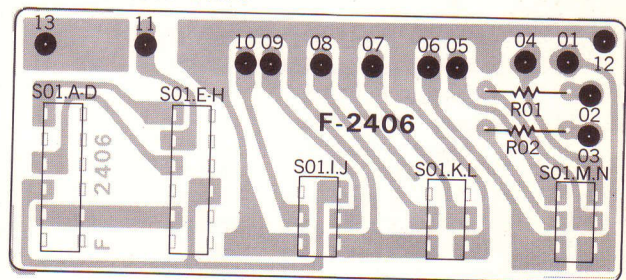

Parts List

Parts No.	Stock No.	Description
R01, 02	0107103	10k Ω 1/4W C.R.
S01	0130860	SUB54 Push Switch (5 Stage)

Abbreviations

- | | |
|---------------------------------|--|
| C.R. : Carbon Resistor | BP.E.C.: Bi-Polar Electrolytic Capacitor |
| S.R. : Solid Resistor | C.C. : Ceramic Capacitor |
| Ce.R. : Cement Resistor | Mi.C. : Mica Capacitor |
| M.R. : Metallized Film Resistor | O.C. : Oil Capacitor |
| M.C. : Mylar Capacitor | P.C. : Polystyrene Capacitor |
| E.C. : Electrolytic Capacitor | T.C. : Tantalum Capacitor |

4-4. F-2407 Volume Circuit Board Conductor Side

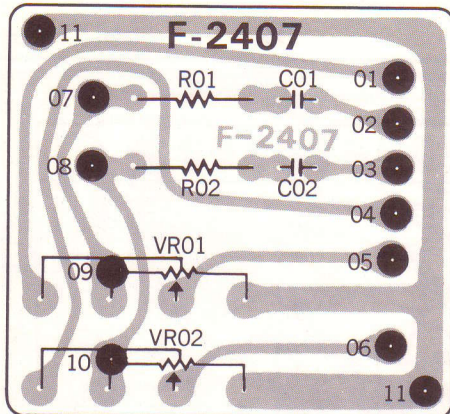

Parts List

Parts No.	Stock No.	Description
C01	0621561	560pF } 50V P.C.
C02	0621561	560pF }
R01	0107153	15kΩ } 1/4W C.R.
R02	0107153	15kΩ }
VR01	1011010, 1	250kΩ (B) × 2 } Variable Resistor
VR02	1011010, 1	250kΩ (B) × 2 }

4-5. F-2408 Accessory Circuit Board (Stock No. 7592110 Complete Circuit Board F-2408) Conductor Side

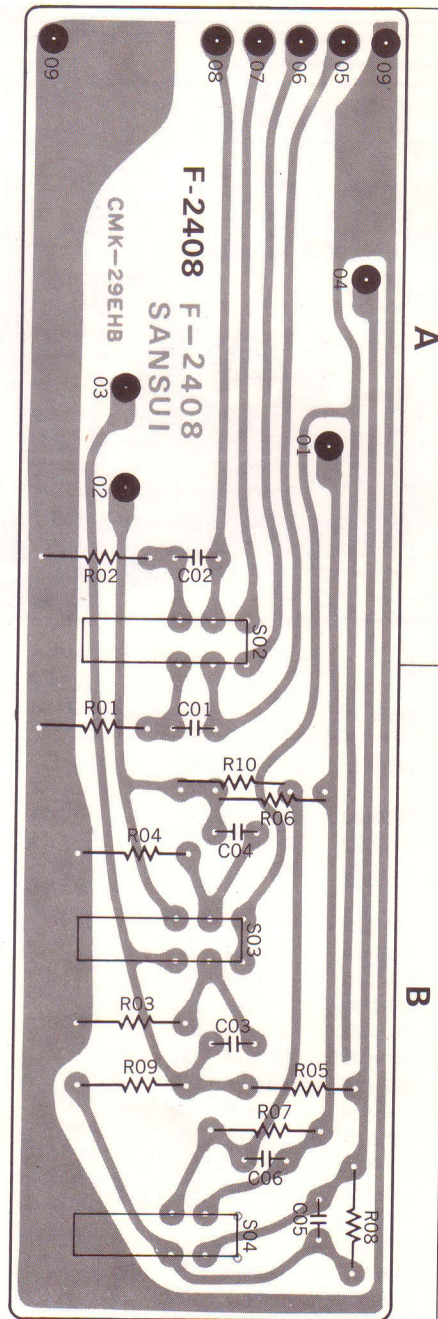

Parts List

Parts No.	Stock No.	Description	Position
C01, 02	0601157	0.015μF } 50V M.C.	B, A
C03, 04	0601157	0.015μF }	B
R01, 02	0107223	22kΩ } 1/4W C.R.	B, A
R03, 04	0107104	100kΩ }	B
R05, 06	0107222	2.2kΩ }	B
S02(a,b)	1170340	SX15-5 } Lever Switch	A
S03(a,b)	1170350	SX15-6 }	B

Abbreviations

C.R. : Carbon Resistor	BP.E.C.: Bi-Polar Electrolytic Capacitor
S.R. : Solid Resistor	C.C. : Ceramic Capacitor
Ce.R. : Cement Resistor	Mi.C. : Mica Capacitor
M.R. : Metallized Film Resistor	O.C. : Oil Capacitor
M.C. : Mylar Capacitor	P.C. : Polystyrene Capacitor
E.C. : Electrolytic Capacitor	T.C. : Tantalum Capacitor

4-6. Other Parts (Front Side)

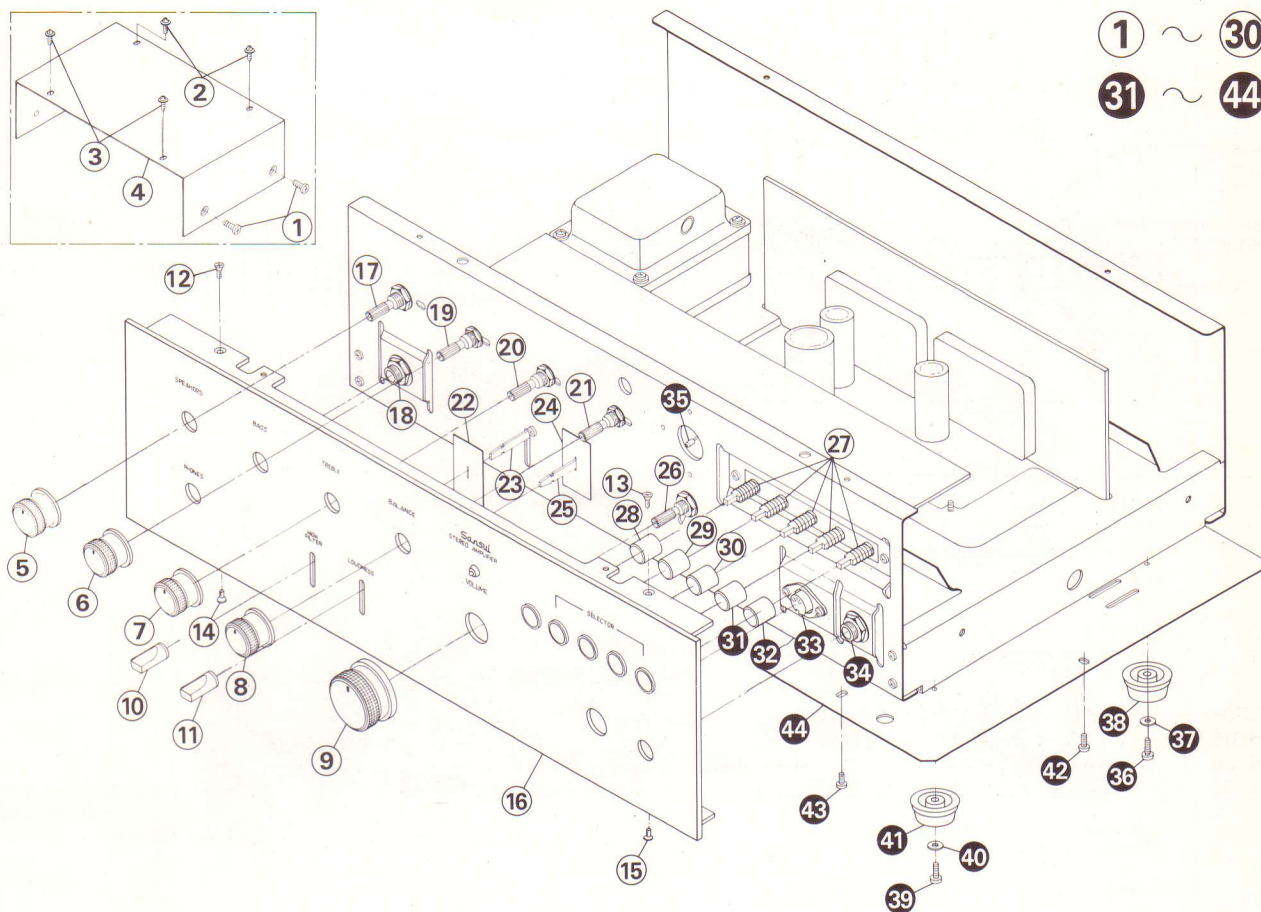

Parts List

Parts No.	Stock No.	Description
1	5101161	Binding Head Screw, M4×6
2	5109222	Binding Head Tapping Screw, 3×8
3	5109222	Binding Head Tapping Screw, 3×8
4	5006310	Bonnet
5	5317880	S-5 Type Knob, SPEAKERS
6	5317880	S-5 Type Knob, BASS volume
7	5317880	S-5 Type Knob, TREBLE volume
8	5317880	S-5 Type Knob, BALANCE volume
9	5317911	M-5 Type Knob, VOLUME
10	5326460	E-1 Type Knob, HIGH FILTER Switch
11	5326460	E-1 Type Knob, LOUDNESS Switch
12	5102543	F Type Screw, M3×6
13	5102543	F Type Screw, M3×6
14	5109122	Binding Head Tapping Screw, 3×8
15	5109122	Binding Head Tapping Screw, 3×8
16	5309290	Front Panel
17	1101550	Rotary Switch Y-1-2-5, SPEAKERS
18	2430190	Headphone Jack
19	1015080	100kΩ (A)×2 BASS volume
20	1015080	100kΩ (A)×2 TREBLE volume
21	1015070	100kΩ (MN)×2 BALANCE volume
22	5047460	Masking, High Filter Switch

Parts No.	Stock No.	Description
23	1170350	LEVER Switch, High Filter
24	5047460	Masking, Loudness Switch
25	1170340	LEVER Switch, Loudness
26	1011010, 1	250kΩ (B)×2 VOLUME
27	1130860	Push Switch (5 Stage)
28	5326500	B Type Push Button
29	5326500	B Type Push Button
30	5326500	B Type Push Button
31	5326500	B Type Push Button
32	5326500	B Type Push Button
33	2430050	DIN Connector
34	2430160	Mic Jack
35	7726080	LED Ass'y (Light Emitted Diode)
36	5166520	Binding Head Screw, M3×12
37	5121340	Washer, M3φ
38	5516940	Rubber Foot
39	5166520	Binding Head Screw, M3×12
40	5121340	Washer, M3φ
41	5516940	Rubber Foot
42	5109222	Binding Head Screw, M3×8
43	5109222	Binding Head Screw, M3×8
44	5058190	Bottom Plate

4-7. Other Parts (Top Side)

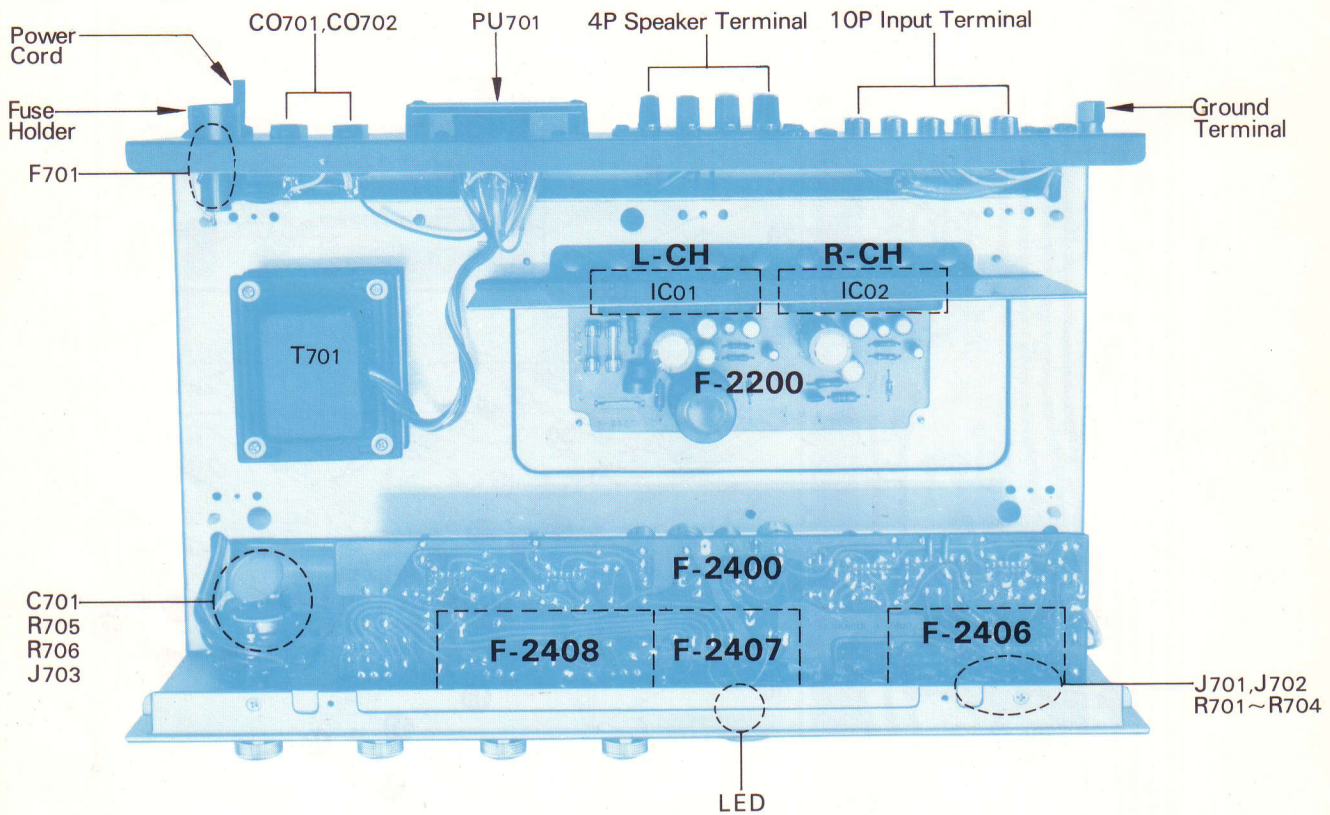

Parts List

Parts No.	Stock No.	Description
IC01, 02	0360130	STK-016B IC
C701	0659801	0.01 μ F 1.4kV C.C.
R701, 702	0107224	220k Ω } $\frac{1}{4}$ W C.R.
R703, 704	0107104	100k Ω }
R705, 706	0103331	330 Ω $\frac{1}{2}$ W C.R.
LED	7726080	Light Emited Diode Ass'y
J701	2430160	Mic Jack
J702	2430050	DIN Jack
J703	2430190	Phone Jack
CO701,702	2450050	AC Outlet

Parts No.	Stock No.	Description
T701	4002080	Power Transformer
F701	{ 0431242 0431232 2300060	{ 2A (100~117V) 1.5A (220~240V) Fuse Holder } Power Fuse
PU701	{ 2410080 2410090	{ Voltage Selector, Socket Voltage Selector, Plug
	2200350	10P Input Terminal
	2210200	4P Speaker Terminal
	2230050	Ground Terminal
	3800020	Power Cord (KP-200)
	3910490	Power Cord Clip

5. SCHEMATIC DIAGRAM

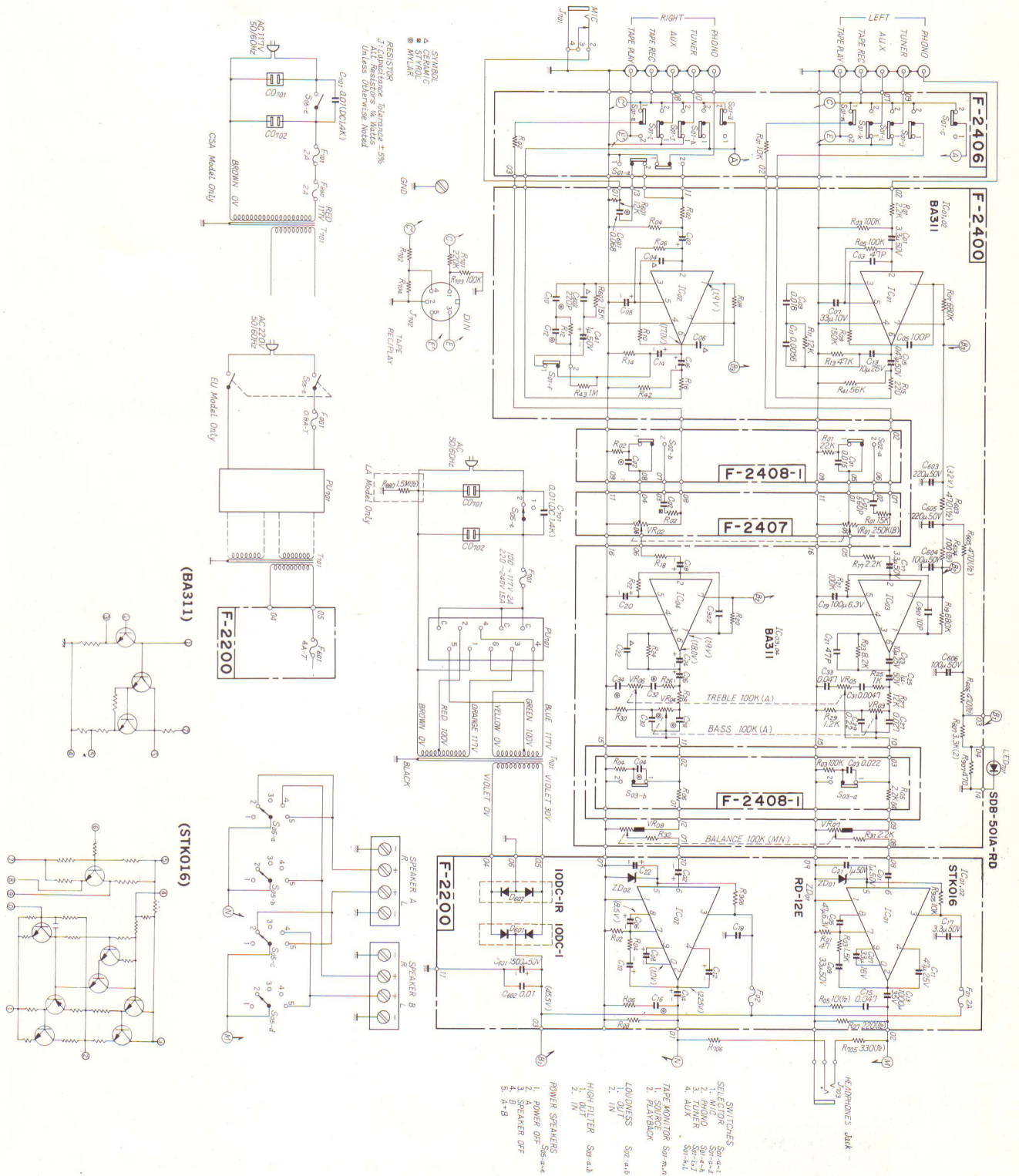

* Design and specifications subject to change without notice for improvements.

6. PACKING LIST

Parts No.	Stock No.	Description
1	9027800	Stylofoam Packing
2	9008061	Corton Case

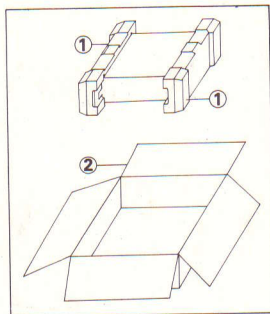

7. ACCESSORY PARTS LIST

Stock No.	Description
0433610	2A Quick Acting Fuse
9208330	Operating Instructions
9228330	Operating Instruction Sheet



SANSUI ELECTRIC CO., LTD.
14-1, 2-chome, Izumi, Suginami-ku, Tokyo 168, Japan
TELEPHONE: (03) 323-1111/TELEX: 232-2076